

**OHIO SCIENTIFIC**

product name/number

24 K MEMORY 527

date

6.27.78

revision

page

status

sheet 1 of 6

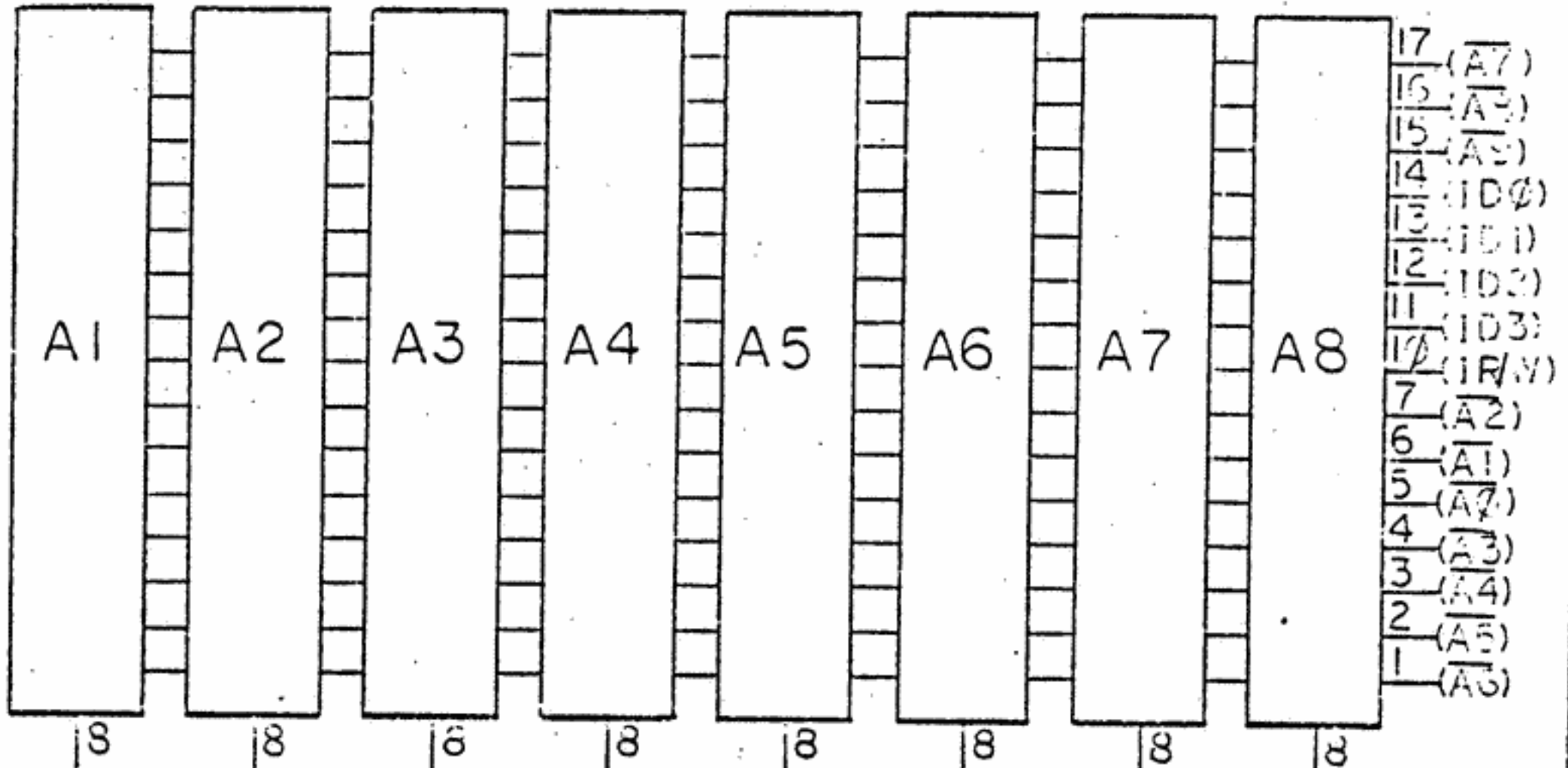

(CE0) (CE1) (CE2) (CE3) (CE4) (CE5) (CE6) (CE7)

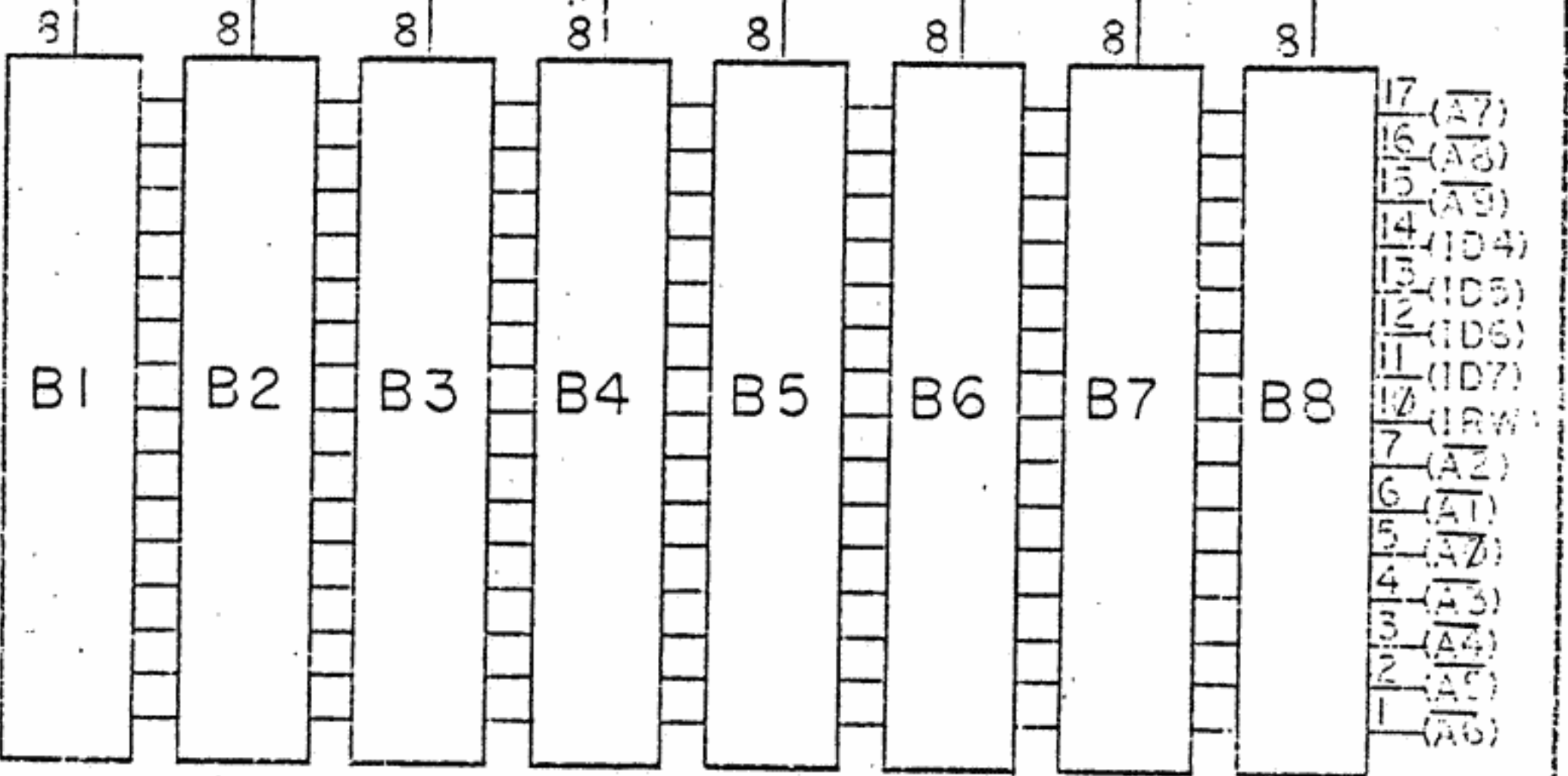

RAMS - 2114

**OHIO SCIENTIFIC**

product name/number  
24K MEMORY 527

date 6-27-79	revision	page	status	sheet 2 of 6
-----------------	----------	------	--------	--------------

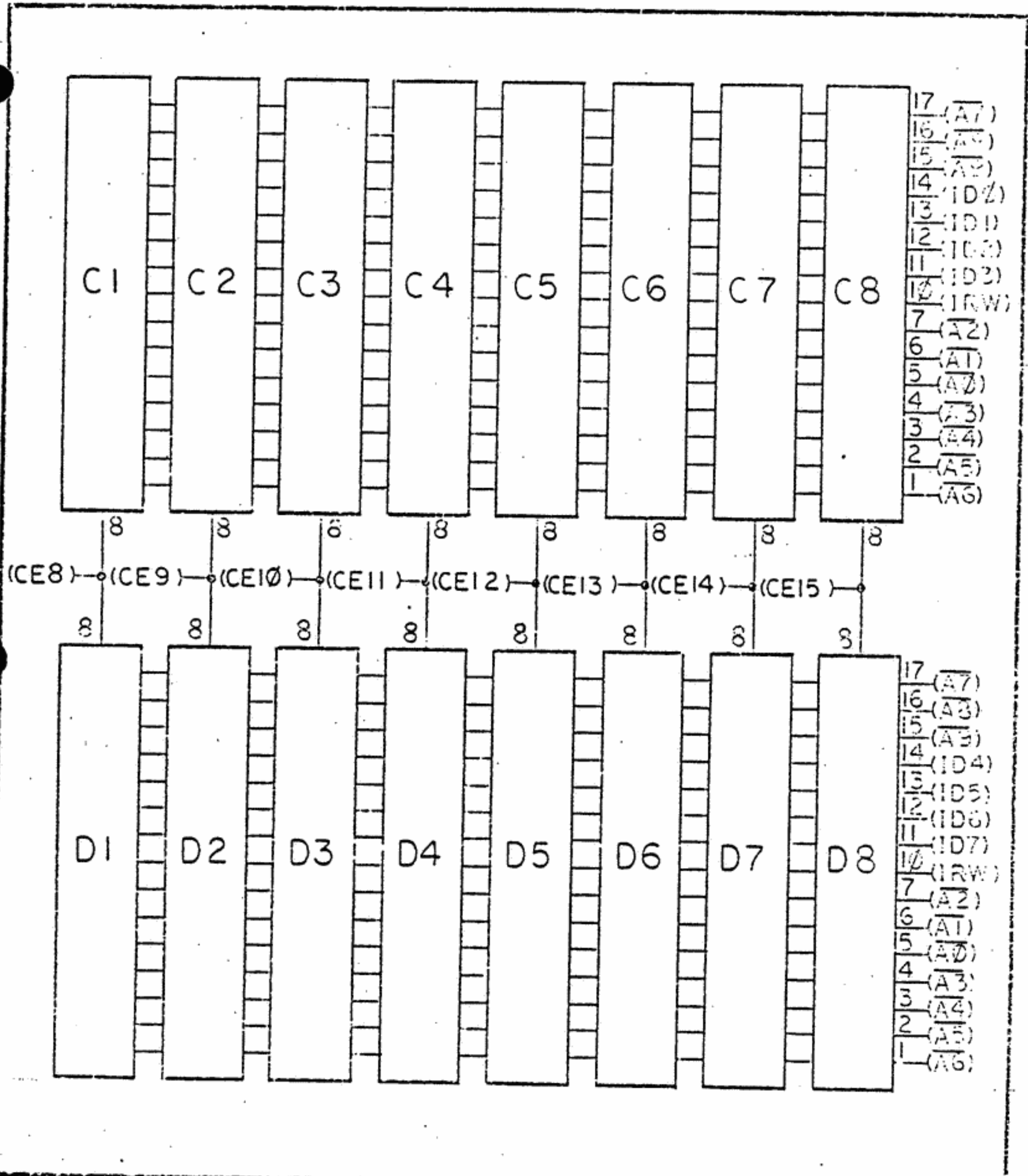

<b>OHIO SCIENTIFIC</b>			product name/number 24K MEMORY 527	
date 6-27-78	revision	page	status	sheet 3 of 6

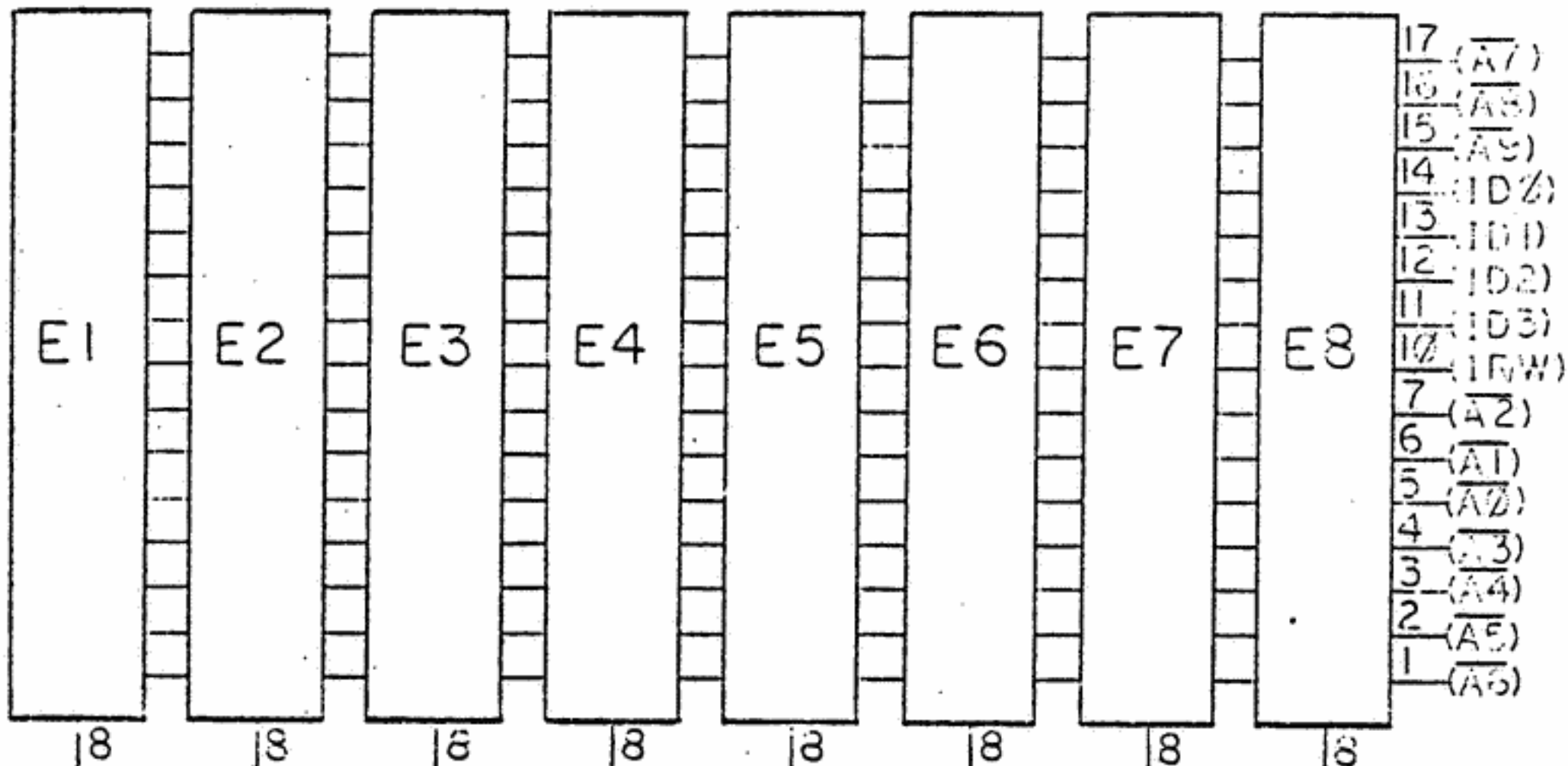

(CE16) — (CE17) — (CE18) — (CE19) — (CE20) — (CE21) — (CE22) — (CE23)

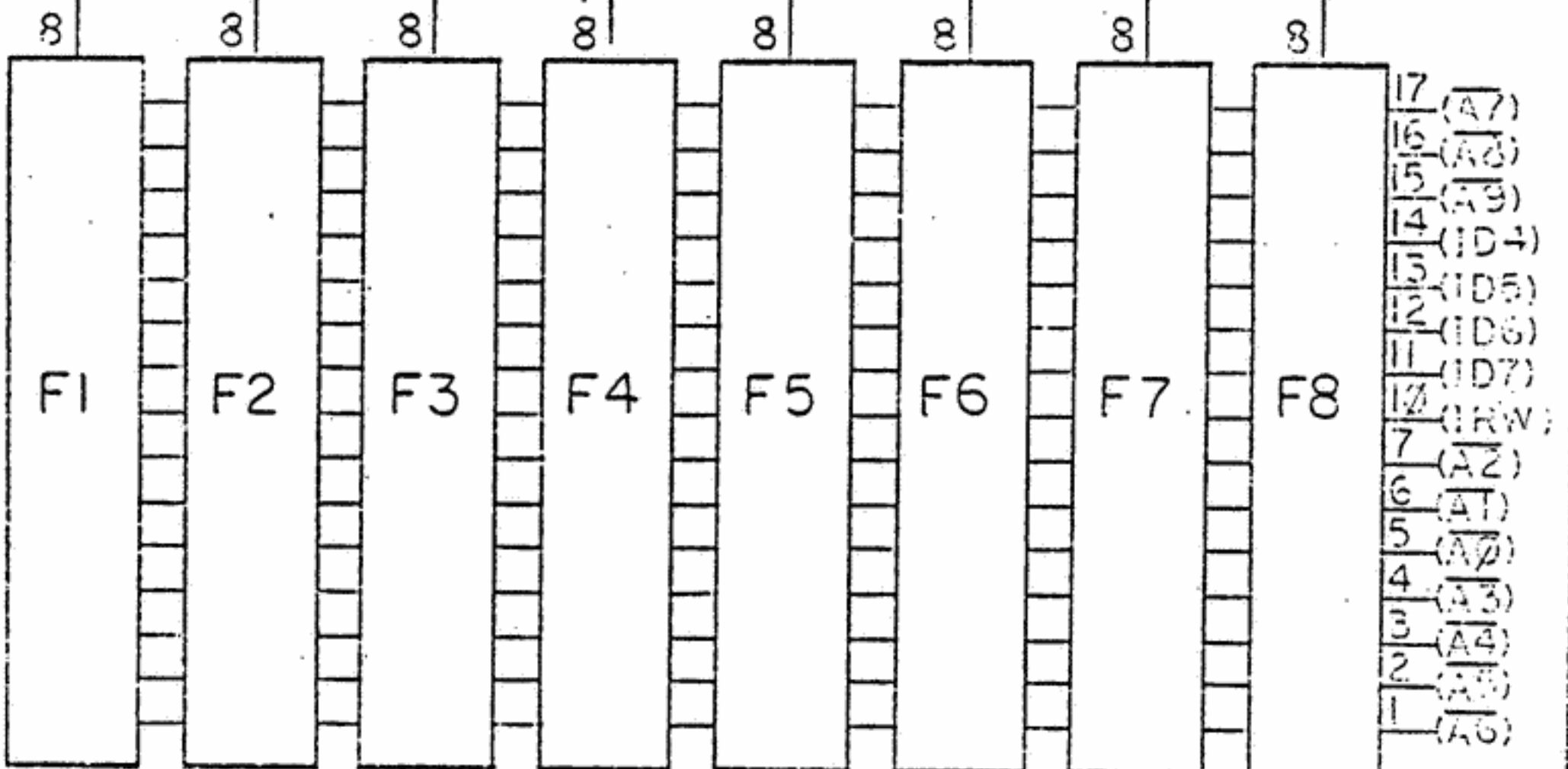

**OHIO SCIENTIFIC**

product name/number  
24K MEMORY 527

date 6-27-78	revision	page	status	sheet 4 of 6
-----------------	----------	------	--------	--------------

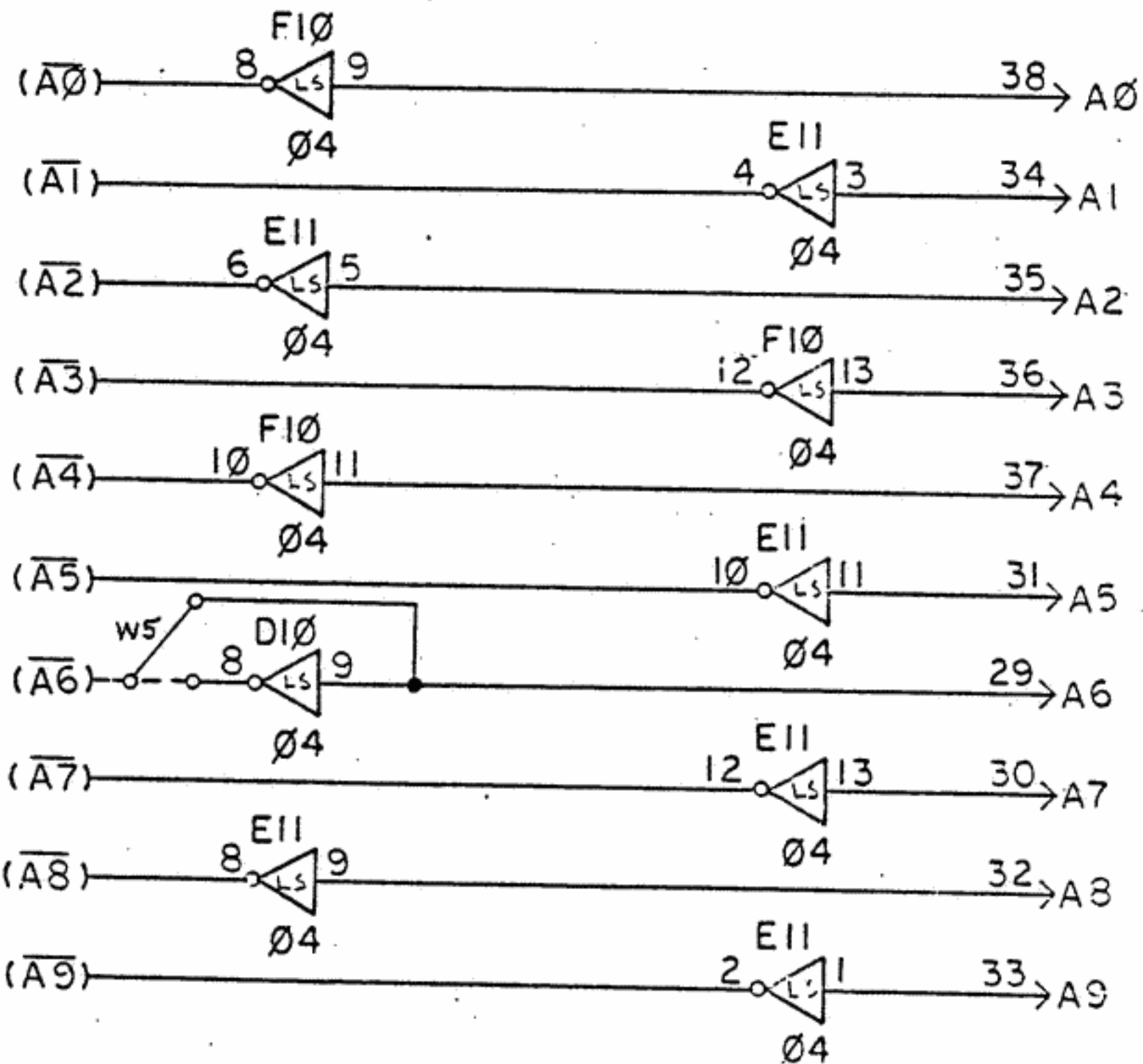
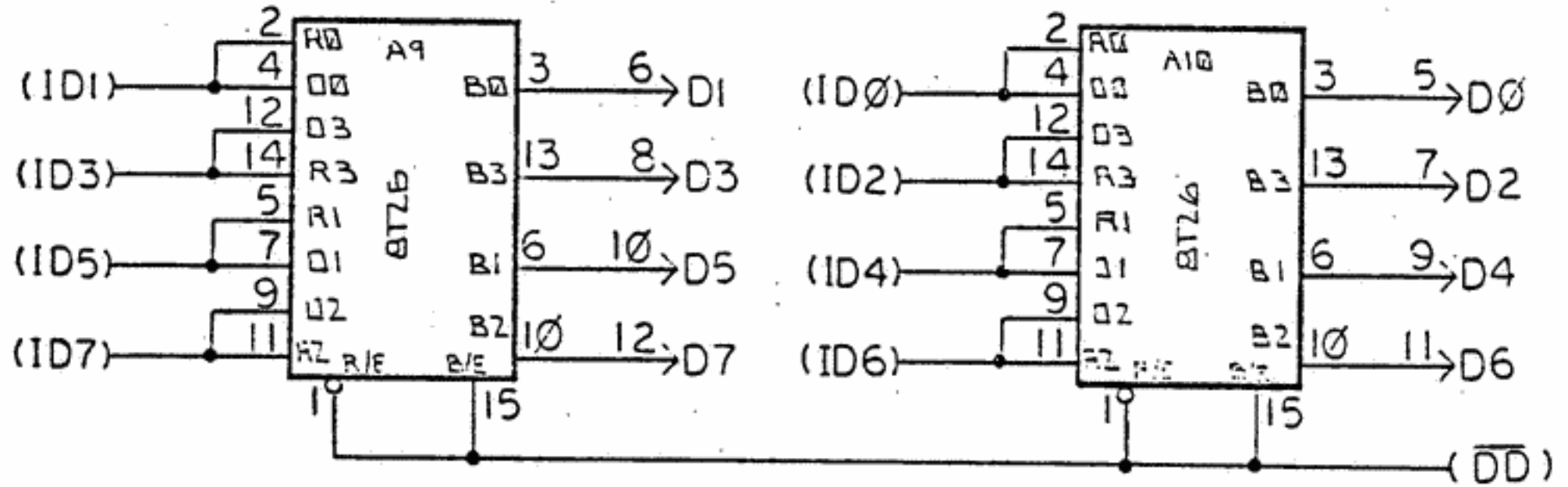

**OHIO SCIENTIFIC**

product name/number  
24K MEMORY 527

date

6-27-75

revision

page

status

sheet 5 of 6



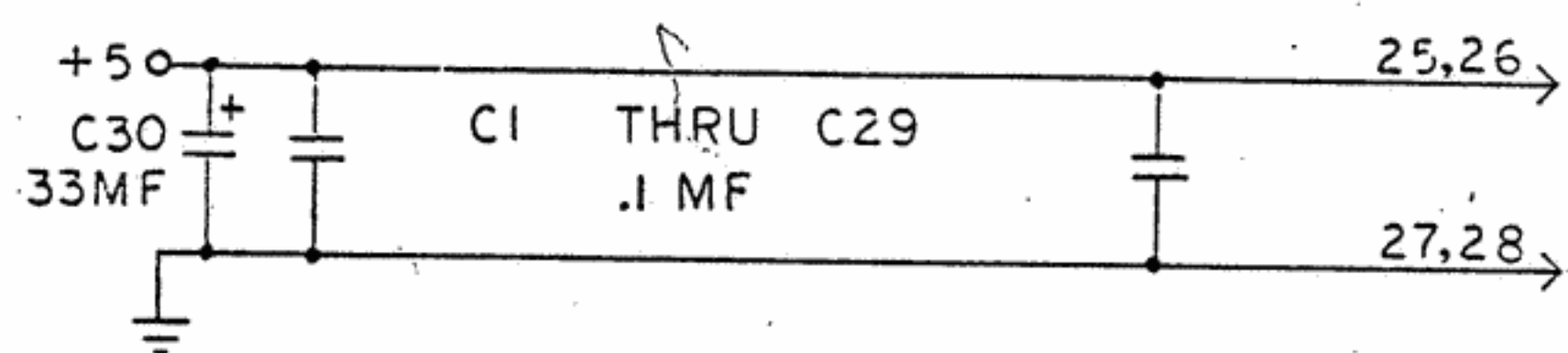
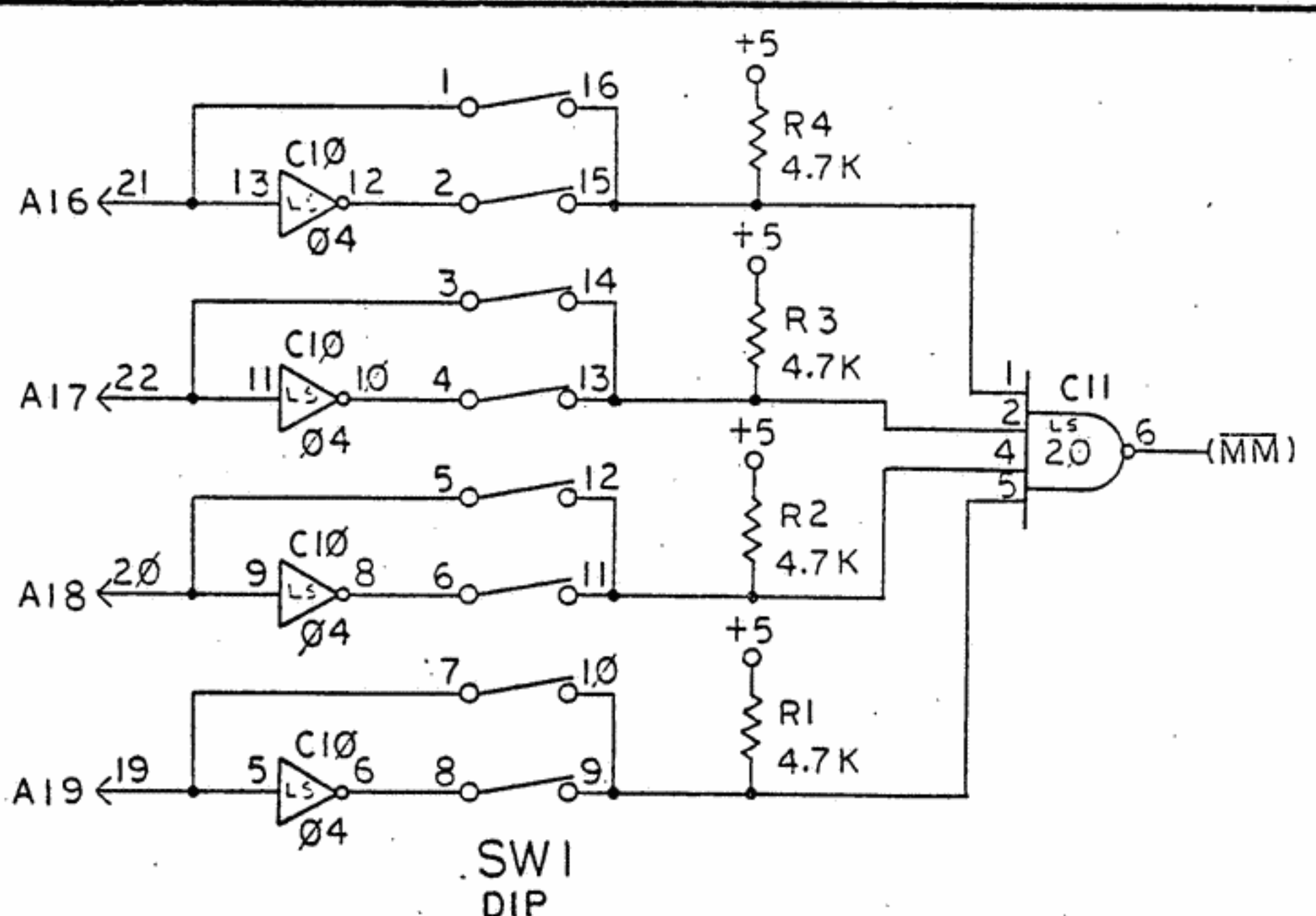

PWR & GND DESIGNATIONS			
DEVICE	+5	GND	OTHER
04	14	7	
10	14	7	
20	14	7	
138	16	8	
8T26	16	8	
8T26	18	9	

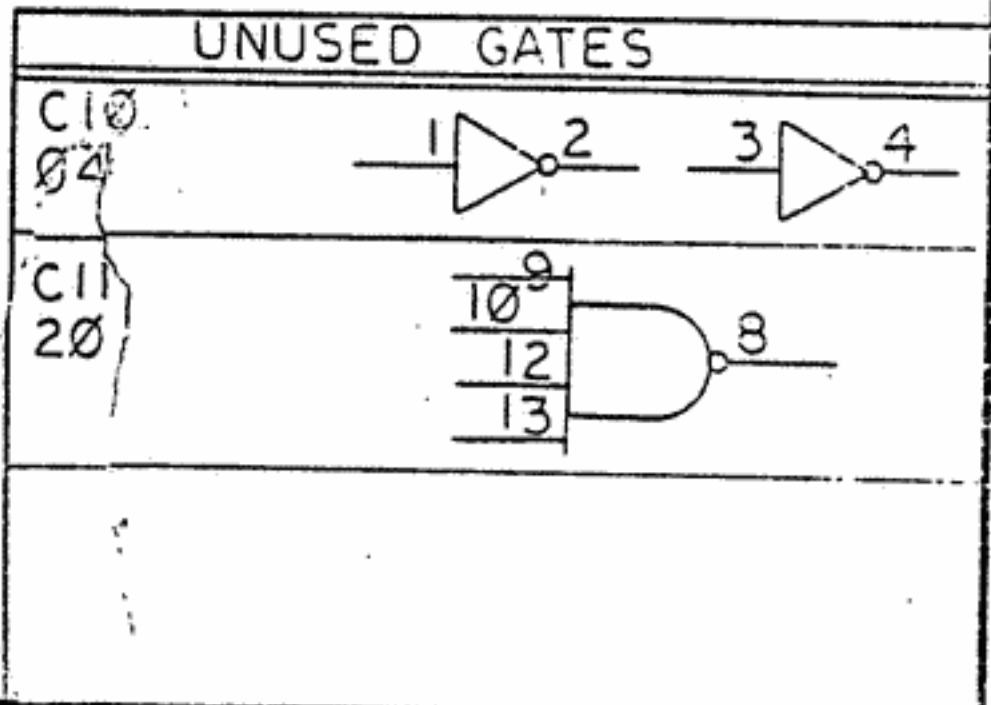

**OHIO SCIENTIFIC**

product name/number  
24K MEMORY 527

date 6-27-78	revision	page	status	sheet 6 of 6
-----------------	----------	------	--------	--------------